

A (x1)

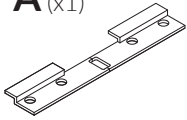

B (x2)

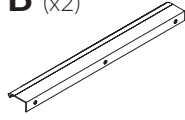

B1 (x6)



C (x2)

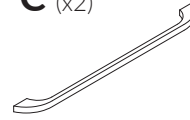

C1 (x4)



1

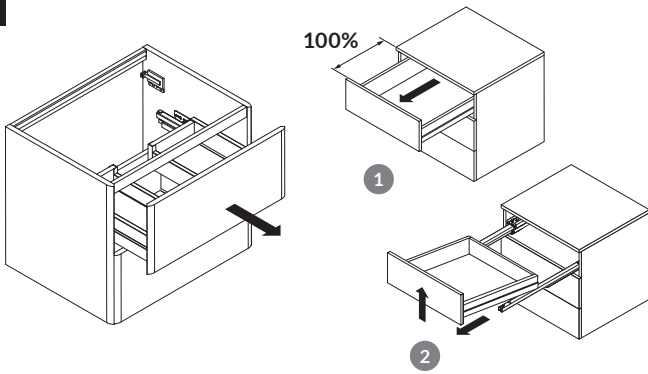

2

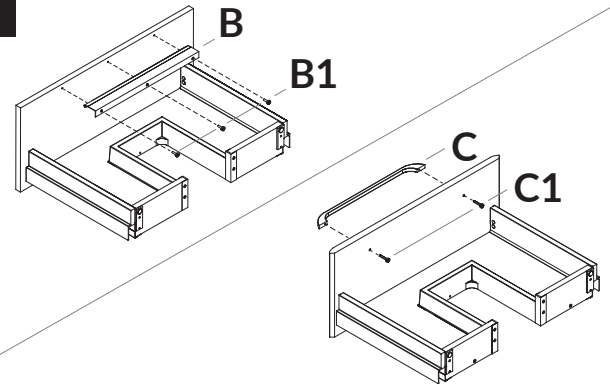

3

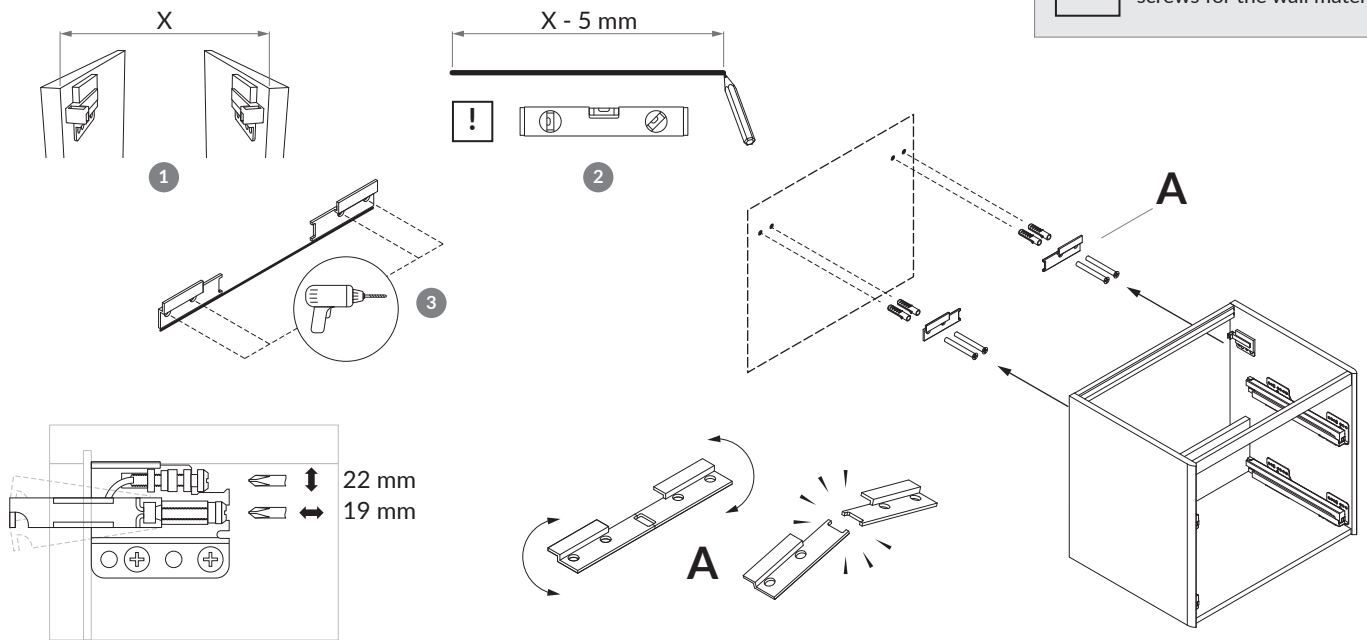

4

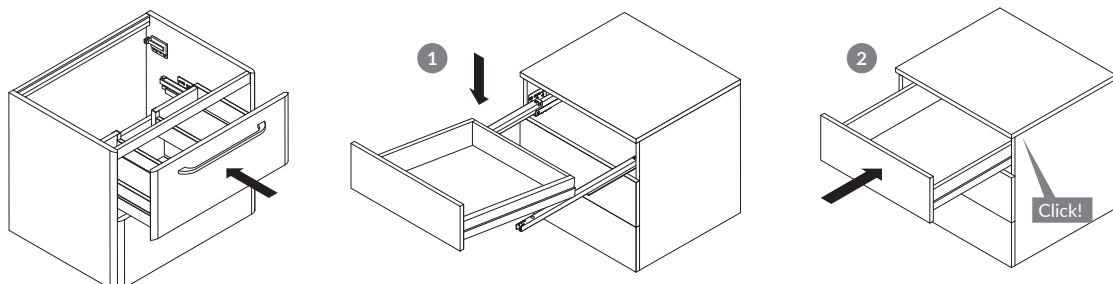

5

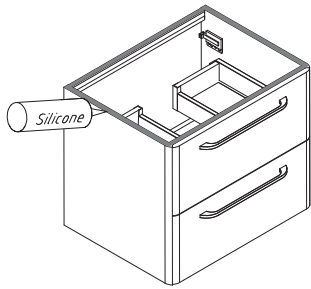

6

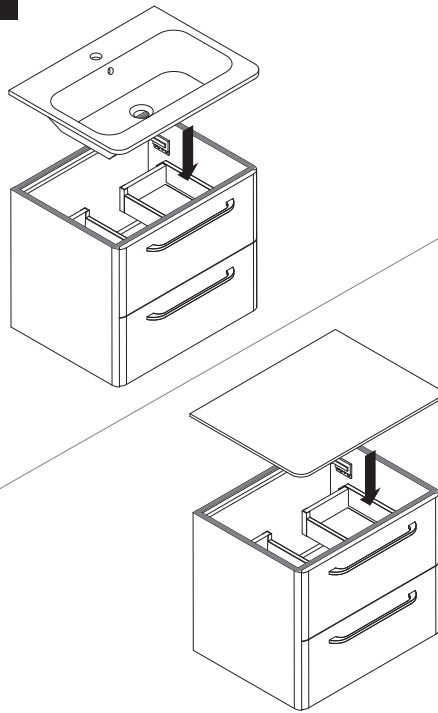

7

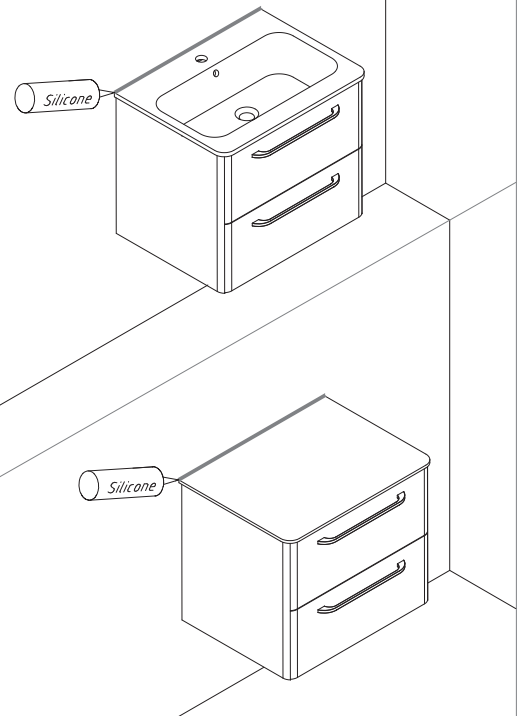

Adjustment

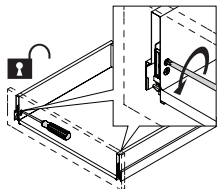
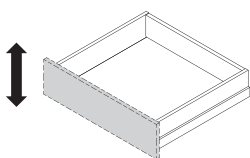

± 2 mm

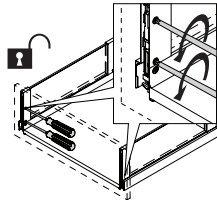
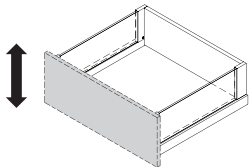
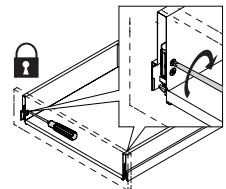
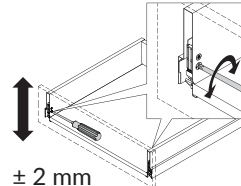

± 2 mm

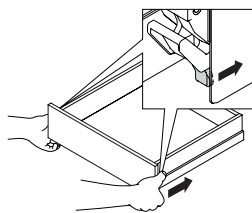
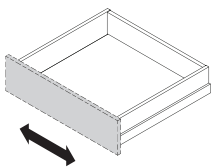
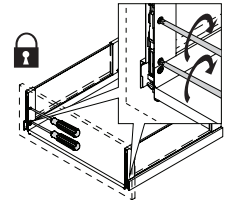
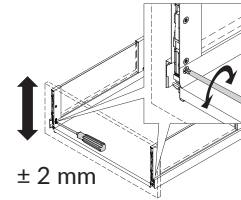

± 1.5 mm

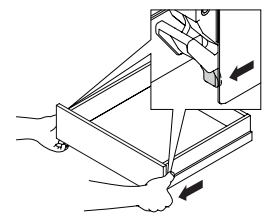
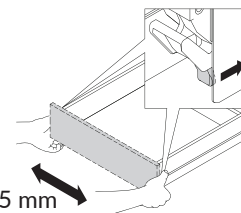

Installation

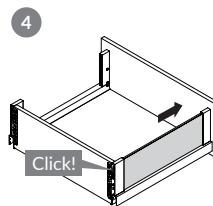
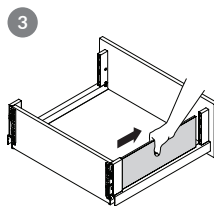
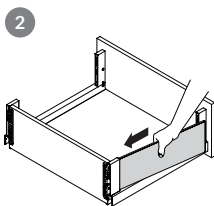
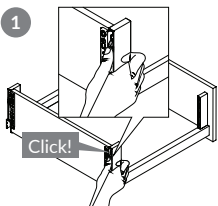

Titl angle adjustment

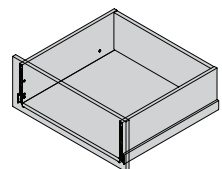

Dismounting

